

Product		Core Material	Core Dimensions	Case Dimensions	Weight in gram	Packaging
D0040R30N01-01		Nanocrystalline	40x32x15 mm	43,5x28,8x18,9 mm	40	85 pcs. pr. box
Housing		Permeability	Frequency	H_{peak}	L_{Fe}	A_{Fe}
Cased	Round	30000	10 kHz	3 mA/cm	11,3 cm	0,48 cm ²

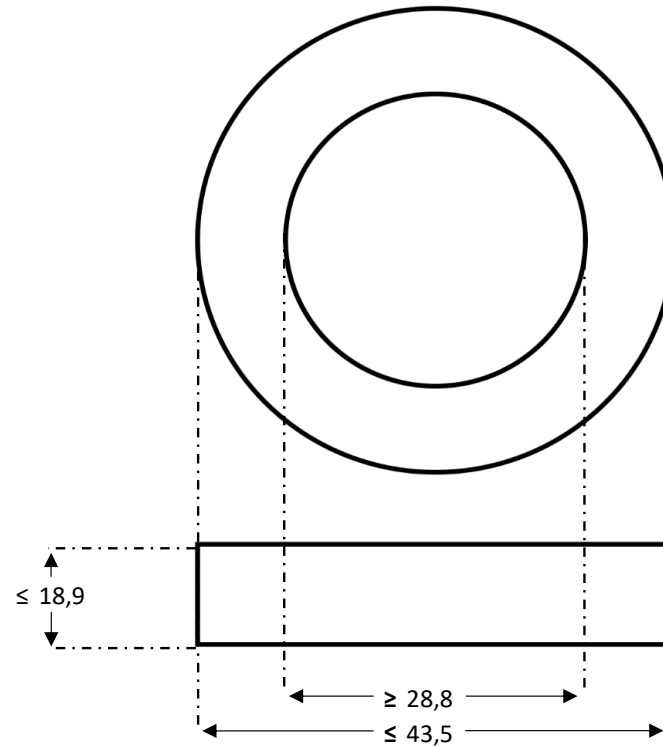

Values in mm

Inspection Values	Measurement limits	Frequency	$I_{eff} \times N$ (mA turns)	Date: 24.03.2023
AL (μH)	11,2 - 22,4	10 kHz	25	Index: 1 Revision: 1
AL (μH)	5,6 - NA	100 kHz	25	Comments:
Created	Approved	Released	Quality	Product released
MWE	MMO	HJP/MMO	HJP	All parameters can be changed without prior notice.

